

Fire Regime Condition Class (FRCC) Interagency Handbook Reference Conditions

Modeler: Ron Masters

Date: 11-24-04

PNVG Code: SHIN

Potential Natural Vegetation Group: Shinnery (Kuchler type 71)

Geographic Area: Southern Great Plains in parts of north Texas, western Oklahoma, southwest New Mexico with disjunct populations in Arizona and Utah. Estimates of the original extent and current acreages vary widely. Estimates of the original extent vary from 6 to 15 million acres and current estimates vary from 5.8 to 7.4 million acres (Peterson and Boyd 1998, Dhillion and Mills 1999).

Description: Dominated by sand shinnery oak (*Quercus havardii*) of the white oak group, occurring on sandy soils, frequently on dunes, occasionally sandy loams or loamy sands; rarely rocky sites or over sandstone. A clonal species occurring in mottes of varying area. Clones average taller and greater in percent canopy cover in the eastern part of the range than the west. Rhizomes several thousand years of age have been reported while above ground portions of the stems may live up to 15 years without disturbance. Historical accounts describe the stature in the northern part of its geographic range as typically 1-2 feet in height; either well interspersed with grasses or as contiguous dense growth of bushes. Recent descriptions put the heights as 1-6 feet, with rare clumps up to 10-12 feet that are presumably the result of hybridization (Pettit 1994, Peterson and Boyd 1998, Dhillion et al 1999, Hoagland 2000). This species hybridizes with post oak (*Q. stellata*) in the eastern part of its range and in the western part of its range with Mohr's oak (*Q. mohriana*) and possibly with *Q. gambelii* and *Q. undulata*.

Woody associates may include sand sagebrush (*Artemisia filifolia*), Oklahoma plum (*Prunus gracilis*), fragrant sumac (*Rhus aromatica*), broom snakeweed (*Gutierrezia sarothrae*) and mesquite (*Prosopis glandulosa*). A northeast to southwest gradient in community composition is evident based on decreasing precipitation, increasing temperature and evapotranspiration, and decreasing sand content of soils. This gradient also influences structure of the stands with oak canopy cover as much as 77% in the north and declining to less than 20% in the more arid southwest part of its range. In Oklahoma, shinnery communities are most often associated with sand sagebrush (*Artemisia filifolia*) and little bluestem (*Schizachyrium scoparium*). In northern communities little bluestem and sand dropseed (*Sporobolus cryptandrus*) are the most dominant grass associates throughout this part of its range, but on dune sands, sand shinnery oak may form near monotypic stands or with a component of sand bluestem (*Andropogon hallii*), big bluestems (*Andropogon gerardii*), giant dropseed (*Sporobolus giganteus*) and switchgrass (*Panicum virgatum*). In the southern extent giant dropseed and Havard's panicum (*Panicum havardii*) are common in occurrence in shinnery stands. Important short grasses include black, blue and hairy grammas (*Bouteloua* spp.) and three-awns (*Aristida* spp.) depending of soil sand composition and soil-moisture relations. Small scale animal disturbance of soil acts to increase within stand heterogeneity and promotes establishment of various grasses and forbs important to maintain species richness for this community (Dhillion 1999).

Herbivory by grasshoppers (Orthoptera) (Peterson and Boyd 1998), prairie dogs (*Cynomys ludovicianus*) (Osburn 1942), and to a much lesser extent mule deer (*Odocoileus hemionus*) and white-tailed deer (*Odocoileus virginianus*) may change structure and canopy cover. Defoliation by grasshoppers may be significant during drought conditions. Other species that may have influenced stand structure include bison (*Bison bison*) and elk (*Cervus elaphus*) but evidently these species had been extirpated from this community relatively early. The shinnery community influenced with fire is very important for lesser prairie chickens (*Tympanuchus pallidicinctus*) (Peterson and Boyd 1998).

Fire Regime Description: Fire regime group II, with frequent stand replacement fires. The fire return interval is not precisely known but for neighboring communities has been estimated at 5-10 years (Wright and Bailey 1982, Boyd and Bidwell 2002). Shinnery is highly susceptible to fire with top-kill of stems close to 100%, regardless of season of burn, but sprouts vigorously following fire increasing stem density (Harrell et al. 2001, Boyd and Bidwell 2002). Oak canopy cover returns to pre-burn levels by 4 years. However, the literature has mixed reports on the fire regime necessary to create mid to later seral open stand conditions. Some reports hypothesize that frequent fire reduced stature and opened the canopy. But recent research suggests that frequent fire of < 3 intervals is necessary to create herbaceous dominance but in stands excluded from fire for 100 years, fires this frequent were not possible due to lack of sufficient fuel (primarily oak leaf litter) (Harrell et al. 2001). However long-term frequent fire may have a different influence on stand structure (Harrell et al. 2001). Also interaction of fire probability and drought cycles have not been reported.

Vegetation Type and Structure

Class*	Percent of Landscape	Description
A: early post replacement	44	Re-sprouting oak stems typically less than 1.5 feet tall with short, mid or tallgrass re-growth dominating the stand depending on geographical location, edaphic conditions and associates. Oak canopy cover < 40%. Grass cover may have the dominant aspect on some sites, depending on grass species.
B: mid-seral closed	34	Occurs by 4 years post-burn. Height may vary from 1.5 feet to 3 feet. Oak canopy cover > 50%. Grass cover may be evident.
C: mid- seral open	10	Occurs 2-4 years post-burn. Height may vary from 1.5 feet to 3 feet. Oak canopy cover < 40%. Grass cover may be evident.
D: late- seral open	2	Rarely occurring from fire, as fire is very effective at top-killing shinnery and given the sprouting ability may occur as a result of edaphic conditions. Oak canopy cover < 40%.
E: late- seral closed	10	From 4-15 years for above ground portions of stems as 15 years is the estimated longevity of individual above ground stems, while underground rhizomes may exceed several hundred to over one thousand years. Oak stems 3-6 feet in height, canopy cover > 50%. Monotypic stands occurring on isolated dune sands may be somewhat fire-proof if blowouts or other fuel discontinuities were present.
Total	100	

*Formal codes for classes A-E are: AESP, BMSC, CMSO, DLSO, and ELSC, respectively.

Fire Frequency and Severity

Fire Severity	Fire Frequency (yrs)	Probability	Percent, All Fires	Description
Replacement Fire	4.3	0.232	85	
Non-Replacement Fire	29.9	0.033	15	
All Fire Frequency*	3.8	0.270	100	

*All Fire Probability = sum of replacement fire and non-replacement fire probabilities. All Fire Fire Frequency = inverse of all fire probability (previous calculation).

References

- Allred, B. W. 1949. Distribution and control of several woody plants in Texas and Oklahoma. *Journal of Range Management* 2:17-29.1
- Blair, W. F., and T. H. Hubbell. 1938. The biotic districts of Oklahoma. *American Midland Naturalist* 20:425-454.

- Boyd, C. S. 1999. The effects of burning season and frequency on the vegetative character and insect abundance of Sand Shinnery Oak range in western Oklahoma. Ph.D. Thesis, Oklahoma State University, Stillwater, OK.
- Boyd, C. S. L. T. Vermeire, T. G. Bidwell and R. L. Lochmiller. 2001. Nutritional quality of shinnery oak buds and catkins in response to burning or herbivory. *Southwestern Naturalist* 10:324-333.
- Boyd, C. S. and T. G. Bidwell. 2002. Effects of prescribed fire on Shinnery Oak (*Quercus havardii*) communities in Western Oklahoma. *Restoration Ecology* 10:324-333.
- Brown, James K.; Smith, Jane Kapler, eds. 2000. Wildland fire in ecosystems: effects of fire on flora. Gen. Tech. Rep. RMRS-GTR-42-vol. 2. Ogden, UT: U.S. Department of Agriculture, Forest Service, Rocky Mountain Research Station. 257 p.
- Bruner, W. E. 1931. The vegetation of Oklahoma. *Ecological Monographs* 1:99-188.
- Dhillion, S. S. 1999. Environmental heterogeneity, animal disturbances, microsite characteristics, and seedling establishment in a *Quercus havardii* community. *Restoration Ecology* 7:399-406.
- Dhillion, S. S., and M. H. Mills. 1999. The sand shinnery oak (*Quercus havardii*) communities of the Llano Estacado: history, structure, ecology and restoration. In: R. C. Anderson, J. S. Fralish, and J. M. Baskin (eds). *Savannas, Barrens, and rock outcrop plant communities of North America*. Cambridge University Press, New York.
- Dhillion, S. S., M. A. McGinley, C. F. Friese, J. C. Zak. 1994. Construction of sand shinnery oak communities of the Llano Estacado: animal disturbances, plant community structure and restoration. *Restoration Ecology* 2:51-60.
- Duck, L. G., and J. B. Fletcher. 1943. A game type map of Oklahoma. *Oklahoma Game and Fish Comm.*, Oklahoma City. 1p.
- Duck, L. G., and J. B. Fletcher. 1945. A survey of the game and furbearing animals of Oklahoma. Pittman-Robertson Series No. II, State Bulletin No. 3. *Oklahoma Game and Fish Comm.*, Oklahoma City. 144p.
- Harrell, W. C., S. D. Fuhlendorf and T. G. Bidwell. 2001. Effects of prescribed fire on sand shinnery oak communities. *Journal of Range Management* 54:685-690.
- Hoagland, B. W. 2000. The vegetation of Oklahoma: a classification for landscape mapping and conservation planning. *Southwestern Naturalist* 45:385-420.
- Kuchler, A. W. 1964. Potential natural vegetation of the conterminous United States. Special Publication 36. American Geographical Society, New York, New York.
- Marcy, R. B. 1854. Explorations of the Red River of Louisiana in the year 1852. Pages 24-25 in 33rd Congress, 1st session, House Executive Document, A. O. P. Nicholson. Washinton,DC 286pp
- McIlvain, E. H., and C. G. Armstrong. 1966. A summary of fire and forage research on shinnery oak rangelands. *Proc. Tall Timbers Fire Ecology Conference* 5:127-129.
- Osborn, B. 1942. Prairie dogs in shinnery (oak scrub) savannah. *Ecology* 23:110-115.
- Osborn, B. and W. H. Kellogg. 1943. Wildlife occurrence and habitat conditions in Roger Mills and Custer counties, Oklahoma. *Proceedings of the Oklahoma Academy of Science* 23:41-43.

Peterson, R. S. and C. S. Boyd. 1998. Ecology and management of sand shinnery communities: a literature review. U.S. Department of Agriculture, Forest Service, Rocky Mountain Research Station. Gen. Tech. Rep. RMRS-GTR-16. Fort Collins, CO. 44 p.

Pettit, R. D. 1977. The ecology and control of sand shin oak. Pages 6-11, *In* Proceedings of the 15th Range Management Conference, Lubbock, TX.

Pettit, R. D. 1979. Effects of picloram and tubuthiuron pellets on sand shinnery oak communities. *Journal of Range Management* 32:196-200.

Pettit, R. 1994. Sand shinnery oak SRM 730. *in* T. N. Shiflet, ed. Rangeland cover types of the United States. Society for Range Management, Denver, CO. 152p.

Rice, E. L. and W. T. Penfound. 1959. The upland forests of Oklahoma. *Ecology* 40:593-608.

Schmidt, Kirsten M, Menakis, James P., Hardy, Colin C., Hann, Wendel J., Bunnell, David L. 2002. Development of coarse-scale spatial data for wildland fire and fuel management. Gen. Tech. Rep. RMRS-GTR-87. Fort Collins, CO: U.S. Department of Agriculture, Forest Service, Rocky Mountain Research Station. 41 p. + CD.

Slosser, J. E., P. W. Jacoby, and J. R. Price. 1985. Management of sand shinnery oak for control of boll weevil (Coleoptera: Curculionidae) in Texas Rolling Plains. *Journal of Economic Entomology* 78:383-389.

U.S. Department of Agriculture, Forest Service, Rocky Mountain Research Station, Fire Sciences Laboratory (2002, December). Fire Effects Information System, [Online]. Available: <http://www.fs.fed.us/database/feis/>.

Welsh, S. L., N. D. Atwood, S. Goodrich, L. C. Higgins. 1993. A Utah flora. Monte L. Bean Life Science Museum, Brigham Young University, Provo, Utah. 986p.

Wiedman, V. E. 1960. Preliminary ecological study of the shinnery oak area of western Oklahoma. M.S. Thesis, University of Oklahoma, Norman, OK.

Wiedman, V. E., and W. T. Penfound. 1960. A preliminary ecological study of the shinnery in Oklahoma. *Southwestern Naturalist* 5:117-122.

Wright, H. A., and A. W. Bailey. 1982. Fire ecology: United States and southern Canada. John Wiley and Sons, New York. 501p.

PERSONAL COMMUNICATION (if applicable):

David M. Engle, Professor, Oklahoma State University
Terrance Bidwell, Professor, Oklahoma State University
Sam Fuhlendorf, Asst. Professor, Oklahoma State University

VDDT File Documentation

Include screen captures (print-screens) from any of the VDDT graphs that were used to develop reference conditions.

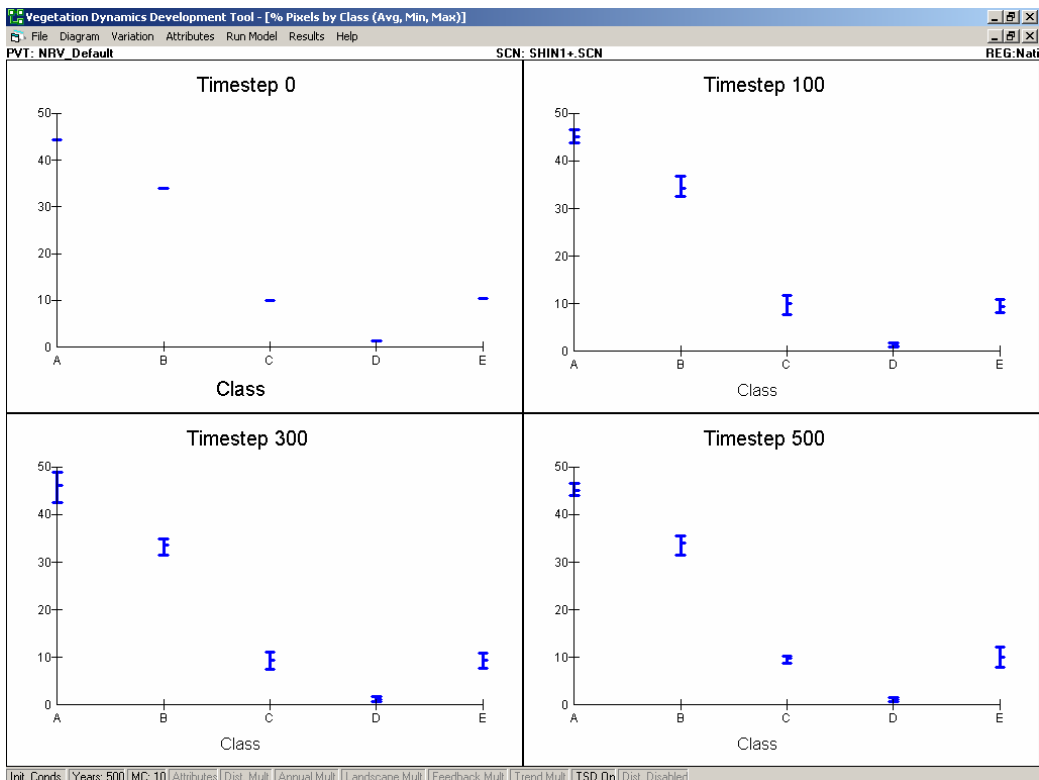
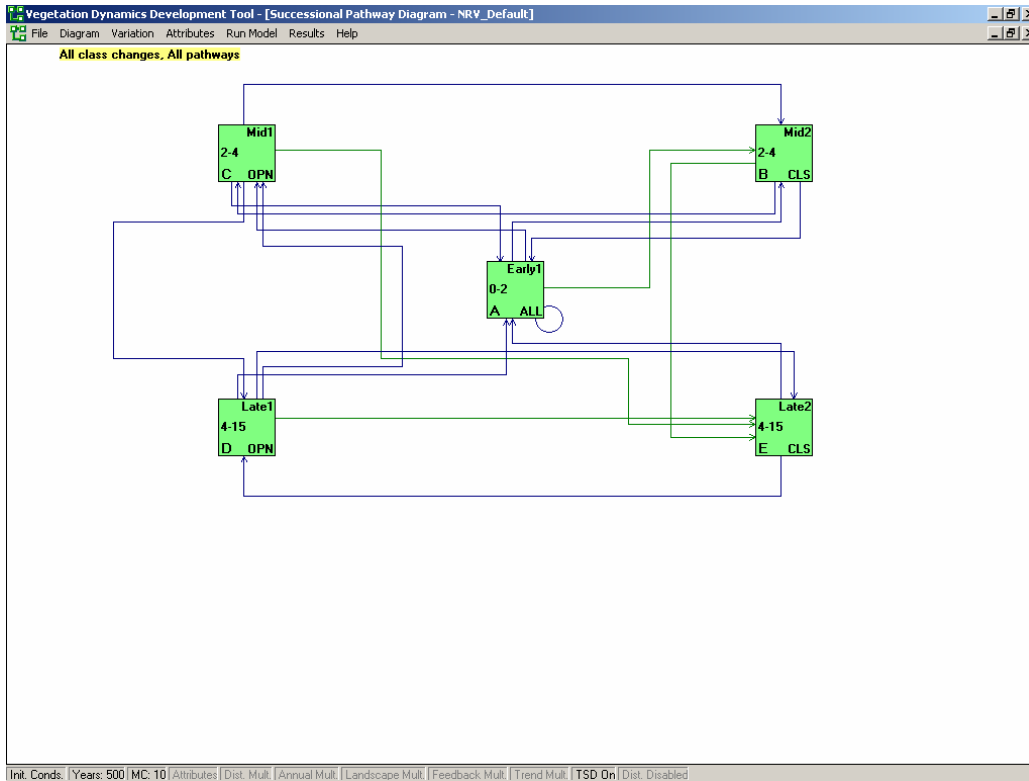

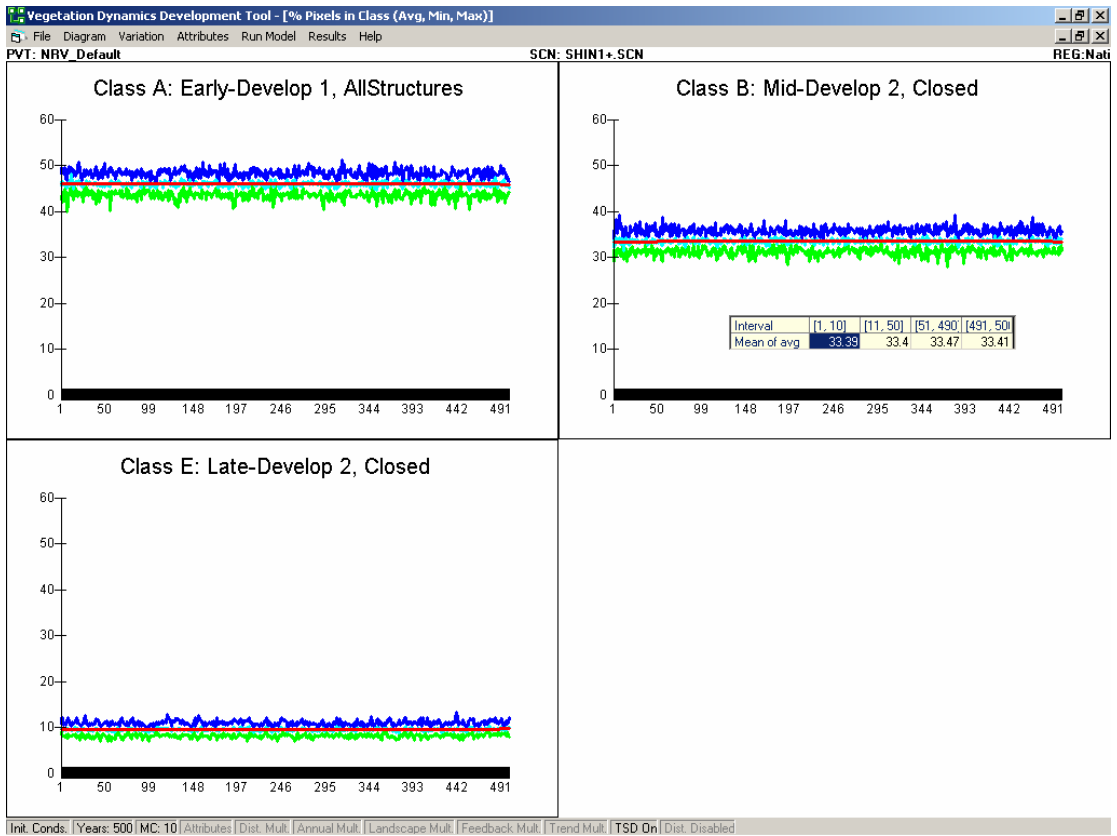
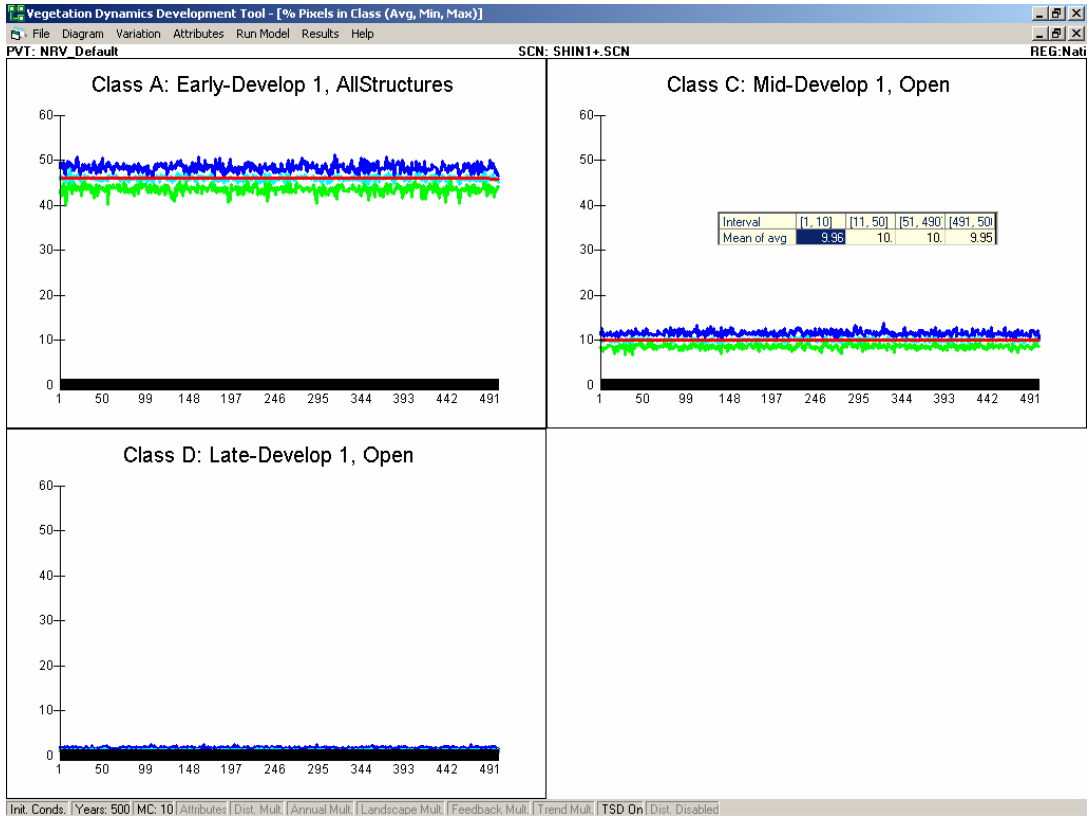

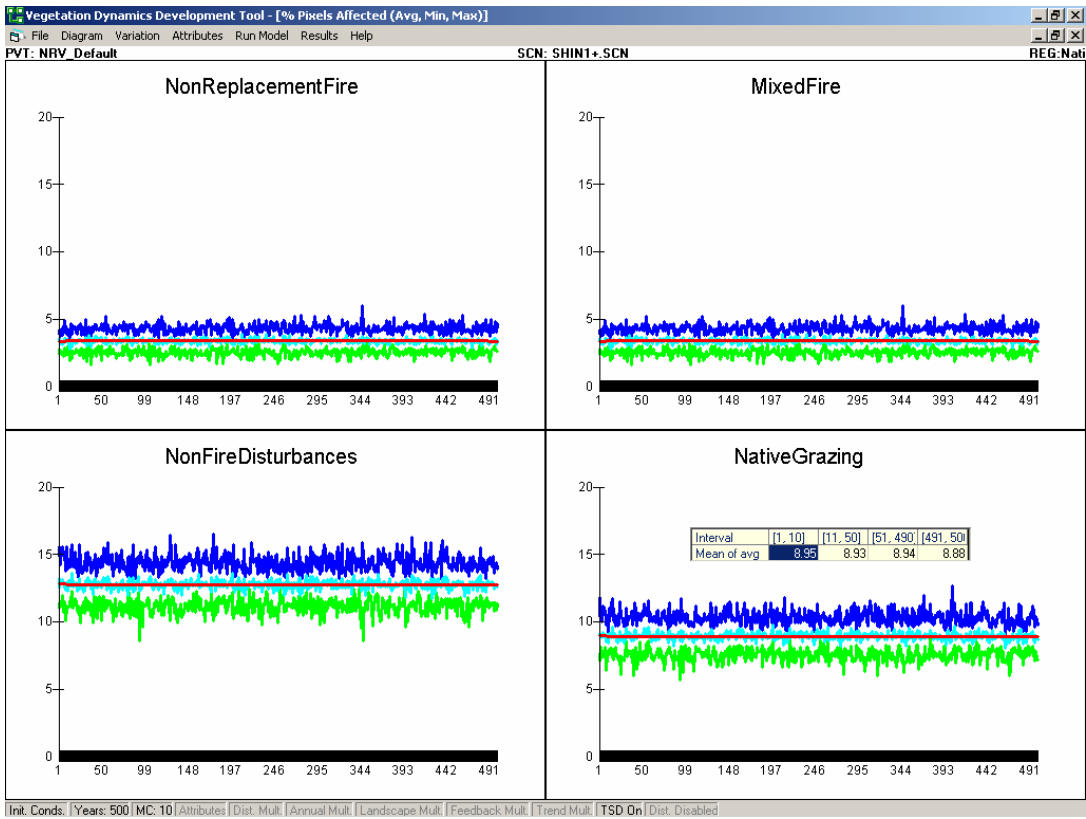
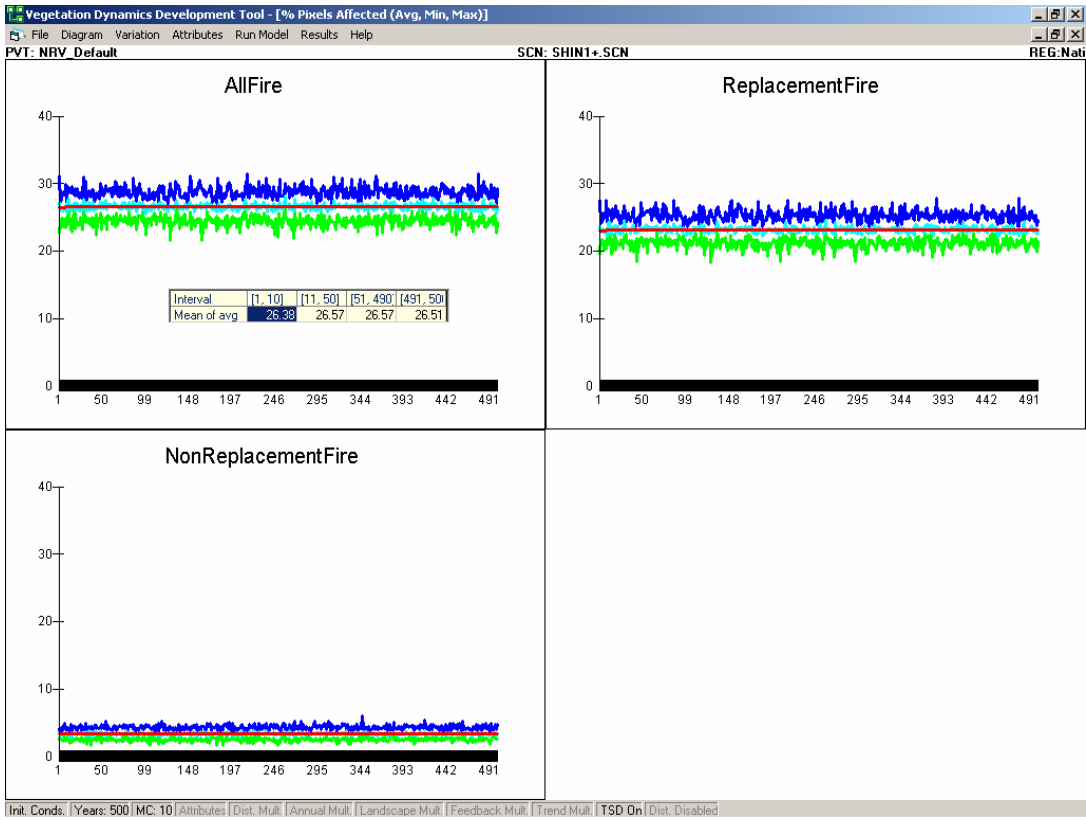

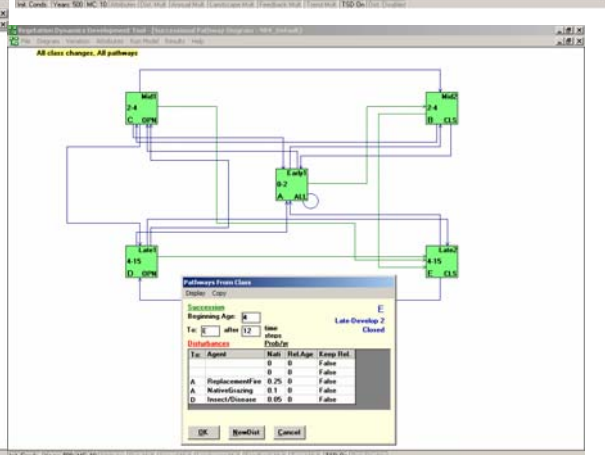
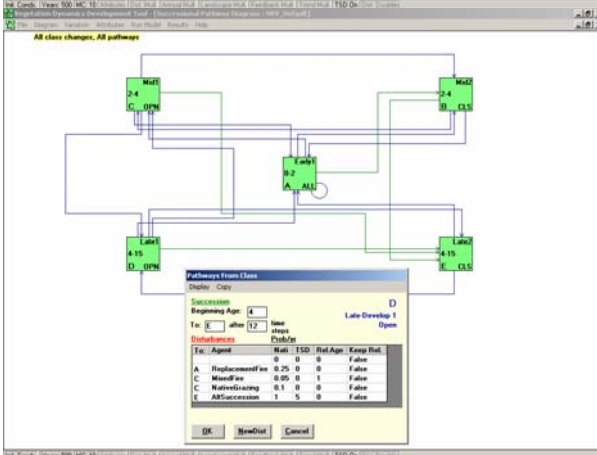
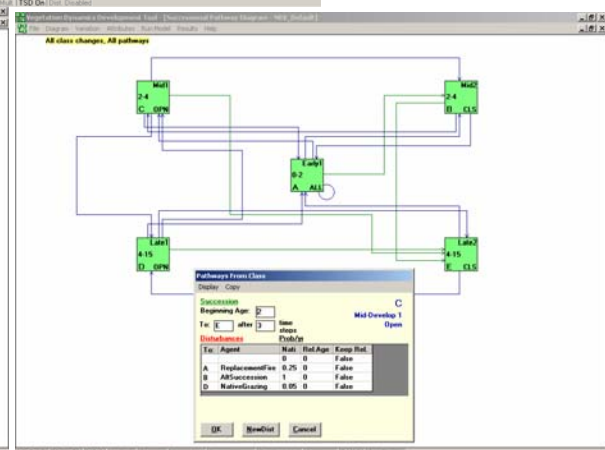
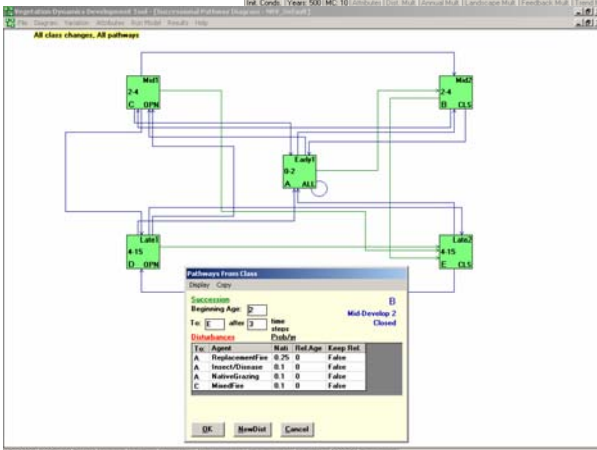
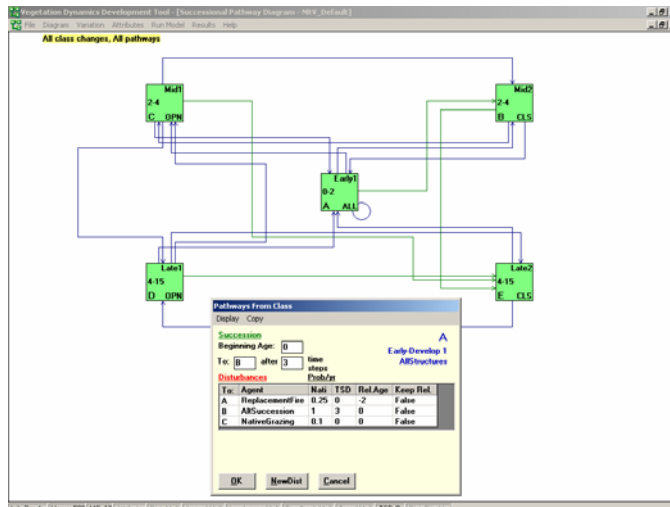

Location map and extent of sand shinnery oak communities. From Peterson and Boyd (1998).

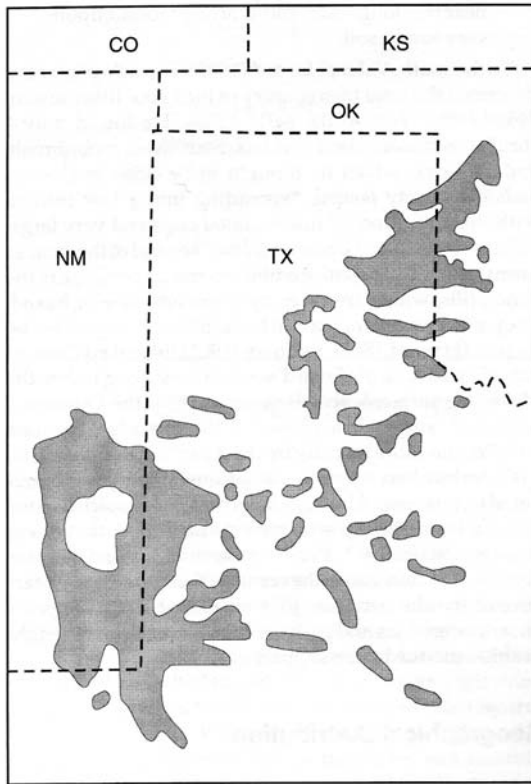

Figure 1. Distribution of sand shinnery in New Mexico, Texas, and Oklahoma. There are also small outlying stands in these states and in Arizona and Utah. The total distribution area of sand shinnery is estimated at 5 to 7 M acres.